



[www.jbfs.co.in](http://www.jbfs.co.in)

# STEEL ROOFING SOLUTIONS

Color Coated Roofing Sheets  
Z & C Purlin | Hat Purlin | Sigma Purlin



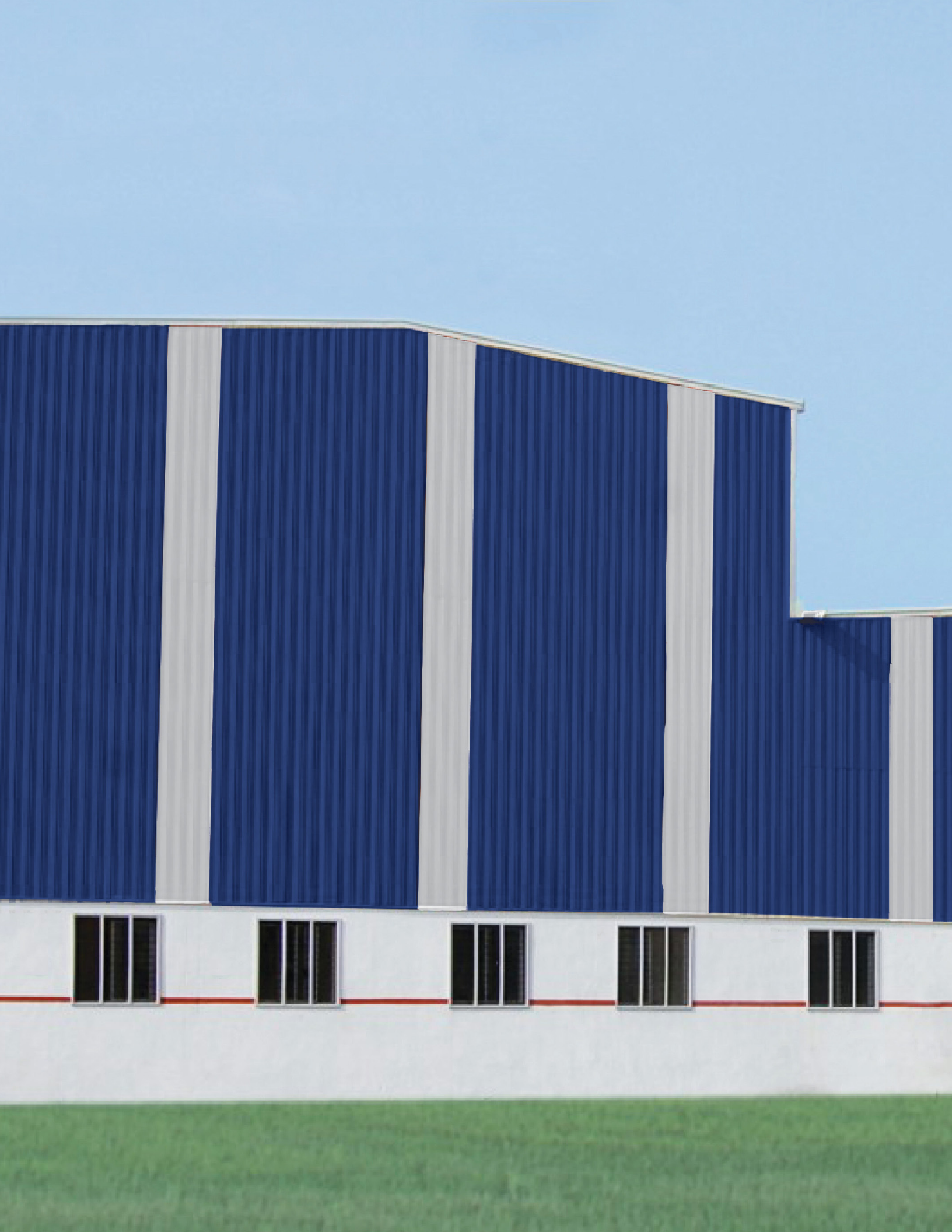

# INDEX

Introduction .....	4-5
Color Coated Roofing Sheets .....	6-19
Z & C Purlin .....	20-25
Hat Purlin .....	26-31
Sigma Purlin .....	32-37
Clients .....	38

# About Us

JBFS Engineering Systems Pvt. Ltd. has been into manufacturing & supplying of a wide range of Concrete Mixers and other construction machines since 1992. The company is accredited with ISO 9001:2015, EUROCERT & EUROKAS; now an established manufacturer, exporter & supply house, providing our services across the nation. Our products are contributing significantly in developing robust infrastructures, carving its name in India's growth story.

Over the years the company has grown exponentially; adding new and innovative products and services to our line-up which now include most of your construction requirements; including profiled Color Coated Sheets and Accessories, Industrial Purlins, Decking Sheets, Portable Cabins and Offices, Pre-Engineered Buildings, Solar Mounting structure, Metal Beam Highway Crash Barriers, Concrete Mixers and Batching Plant, Construction Machinery, Shuttering & Scaffolding materials, and most recently Green Steel Building Solution -LGSF.

Our innovative and value-based products are admired and acknowledged for its quality, durability, strength, and superior technology. The products are designed following the key fundamentals of reliability, safety, durability, and utility thereby allowing you to achieve better performance, quality, and cost-effectiveness in your projects through our products.

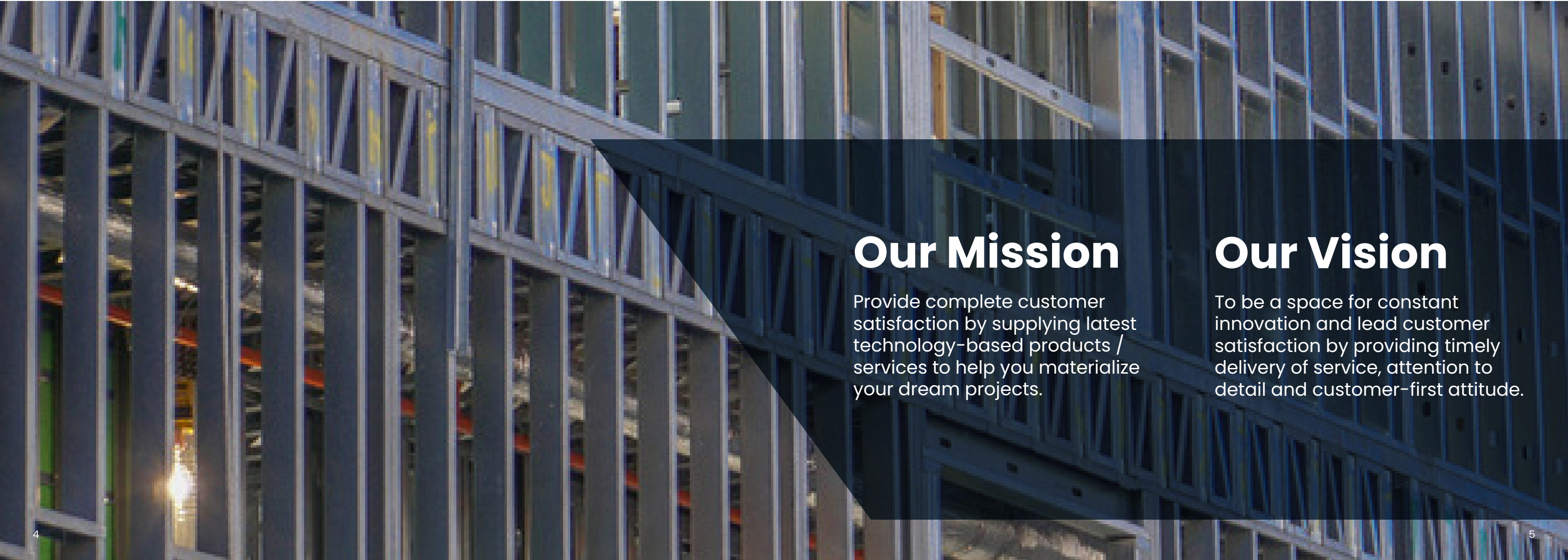

## Our Mission

Provide complete customer satisfaction by supplying latest technology-based products / services to help you materialize your dream projects.

## Our Vision

To be a space for constant innovation and lead customer satisfaction by providing timely delivery of service, attention to detail and customer-first attitude.

# COLOR COATED ROOFING SHEETS

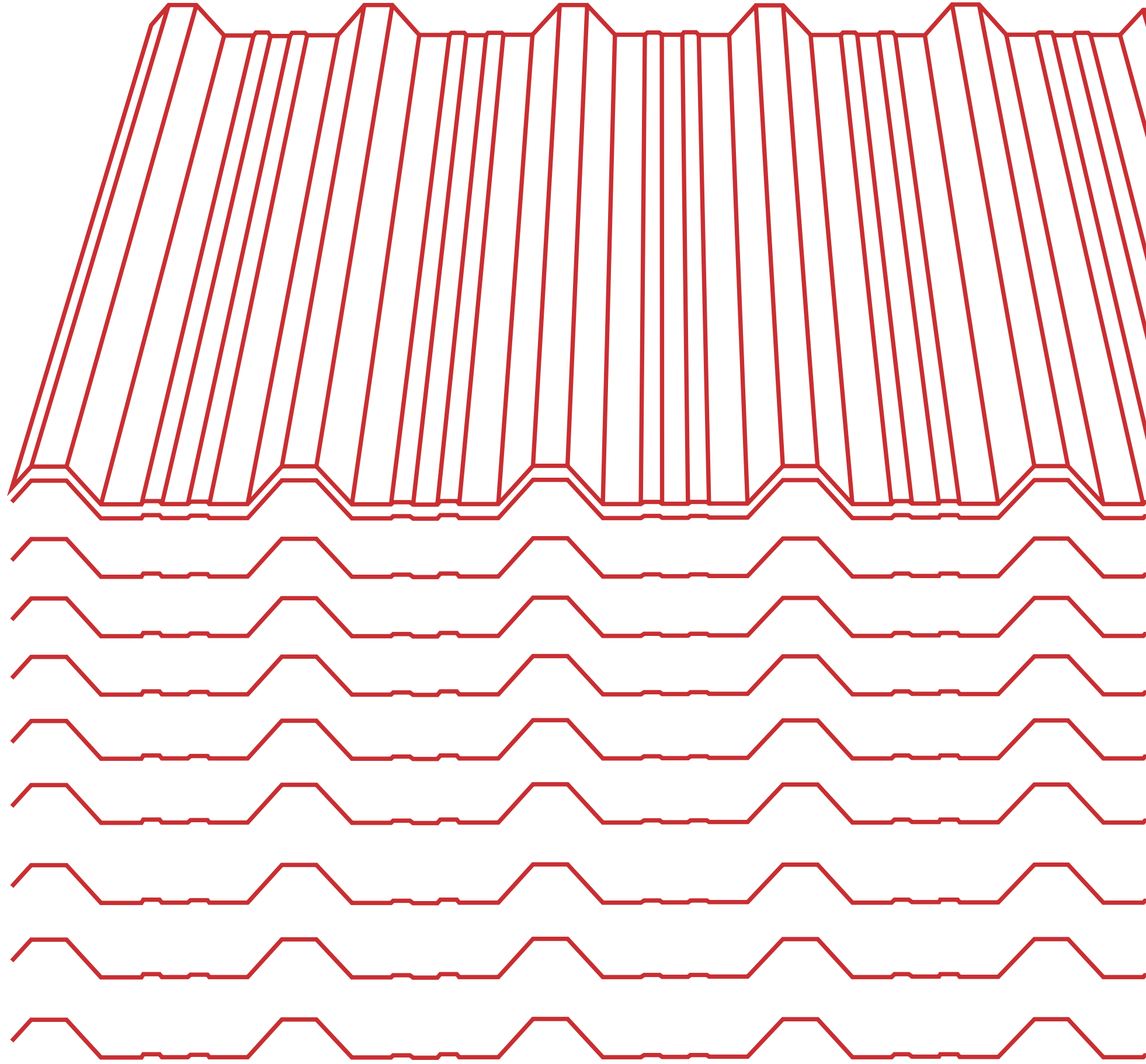

Trapezoidal profile

# COLOR COATED ROOFING AND WALL CLADDING

JBFS FlexiBal® Color Coated Roofing sheets are profiled out of lightweight, high tensile strength steel sheet. Available in a wide range of pre-painted steel roofing and wall profiles including trapezoidal sheets and corrugated sheets system. The FlexiBal® Color Coated roofing sheets, wall cladding sheets and roofing accessories are accurately roll-formed using Precision Automatic Roll Forming machine from steel base which is coated with either Zinc (Galvanise)[100% Zinc] or Zinc-Aluminium Alloy (Galvalume)[ 55% Aluminium, 43% Zinc, 1.5% Silicon]. The superior paint coating over our products ensures that the roof looks new for many years withstanding extreme weather conditions, without surface discolouration. Roofing sheets come with an anti-capillary groove that ensures leakproof performance during heaviest of rain.

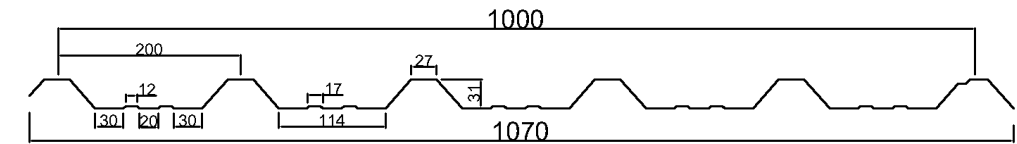
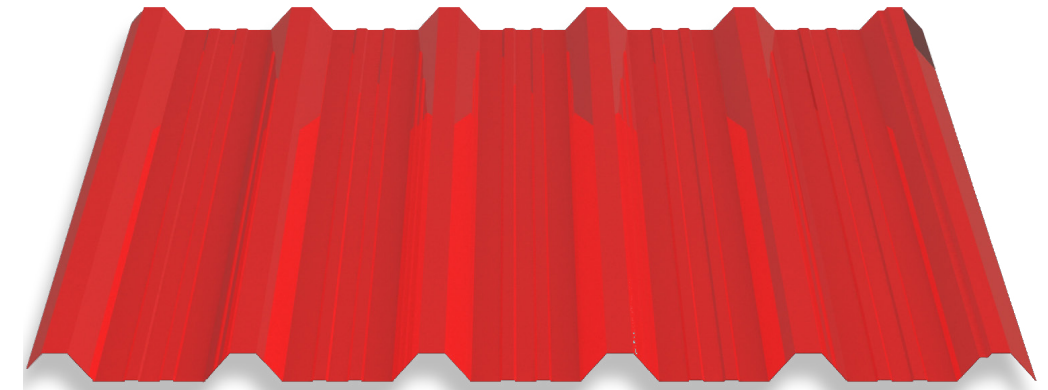

Our profile has 31 mm deep major ribs, spaced at 200 mm from the centre with two additional minor stiffening ribs for extra strength spaced 30 mm from the major ribs; thereby having an effective coverage of 1 metre. Thereby providing high coverage with a reduced number of sheets.

## Product Details

Covered Width	1070 mm
Effective Width	1000mm
Length	as per requirement
Thickness	0.4 / 0.45 / 0.47 / 0.5 / 0.55 / 0.6 / 0.7 / 0.8 mm
Pitch Distance	200mm
Rib Height	31mm
Color	Available in 14 colors
Corrosion Coating	PPGI / PPGL
Corrosion Coating Mass	Z-90 / Z-120 / AZ-70 / AZ-150 / AZ-275
Primers	Epoxy, PU, Polyester
Paint Type	RMP / SMP / PVDF / SDP



# 8-layer Protection

The JBFS FlexiBal® profiled Color Coated Roofing products bring together the strength of steel, the beauty of paint with Weather Resistant Anti-Corrosion coating in an unbeatable package. The pre-painted Trapezoidal profile sheets are available in Galvanised or Galvalume coating. Our pre-painted products are available in a variety of paint systems, including Regular Modified Polyester (RMP), Silicon Modified Polyester (SMP), Super Durable Polyester (SDP) and Poly Vinylidene Fluoride (PVDF). The paint coating provides not only external beauty but additional protection against harsh weather conditions and other factors that impact an installations longevity. The process of color coating of steel is done according to EN 10169:2010 standards.

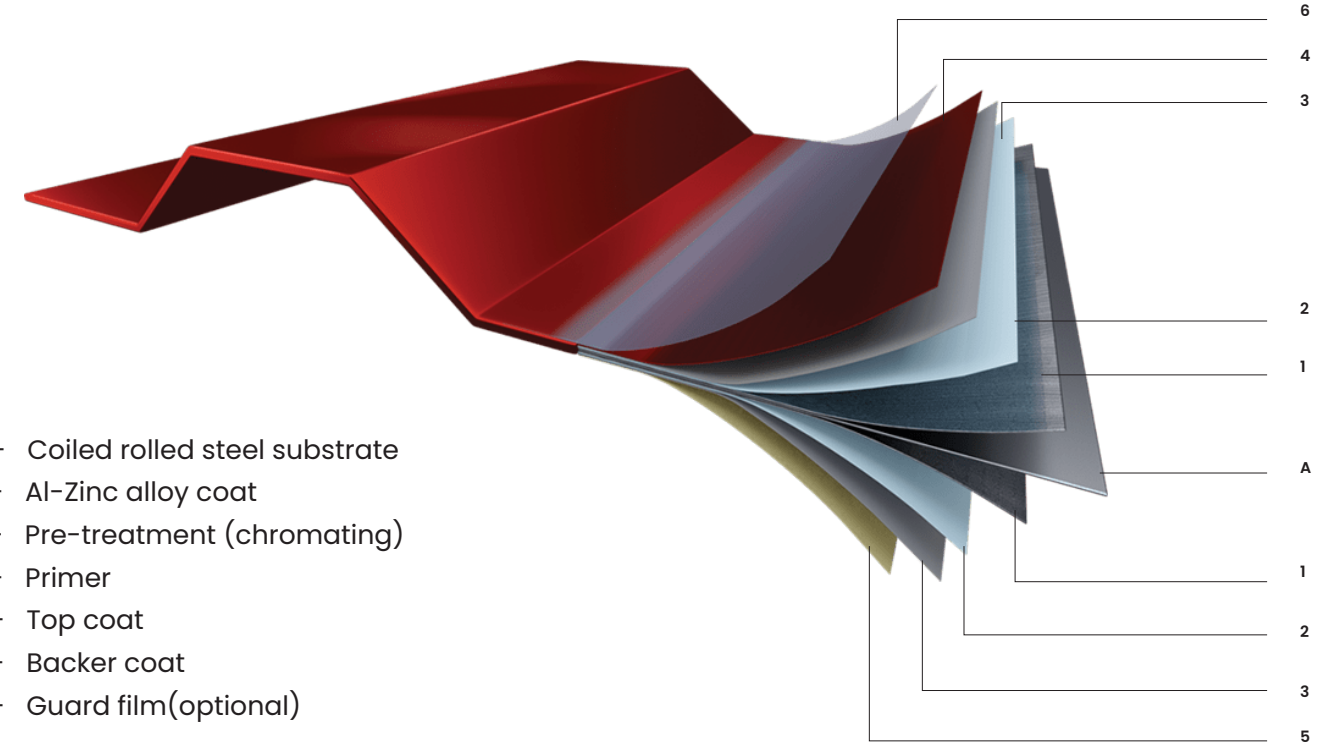
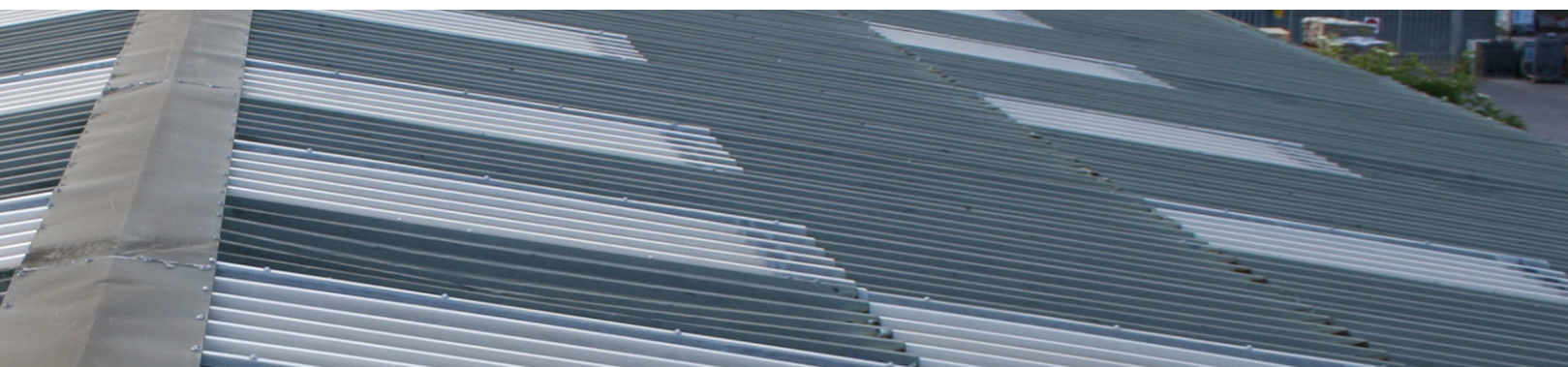

- A - Coiled rolled steel substrate
- 1 - Al-Zinc alloy coat
- 2 - Pre-treatment (chromating)
- 3 - Primer
- 4 - Top coat
- 5 - Backer coat
- 6 - Guard film(optional)

## Performance Testing

Specification	
Scratch Hardness (T/B)	1.5 - 2 / 1 - 1.5 Kg
Impact Test (in Joules) (thickness based Soft material)	As per Standard
Salt Spray Test (Specific to Coating Type)	750-1000 hrs
Adhesion Test (cross-hatch)	100%
Erichsen Cupping Test	As per Standard
Humidity Test	750-1000 hrs
T- Bend Test (T = substrate thickness)	2T for Soft, 4T for Hard (no tape loss)
Water Boiling Test	As per Standard
Solvent Rub Test (MEK- double rub)	> 100DR For Non Metallic, 80DR Metallic.
Chemical Resistance	As per Standard
Max. Operating temp	Upto 140°C



# Features

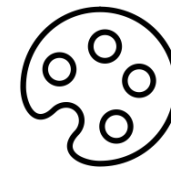

Attractive colors & Flexible designs



Very low maintainace



High strength to weight ratio



Minimum yeild strength of 550 MPA ensures



Withstand wind speed



Strong durable & total safety



Environment friendly & Fire proof



Leak proof & resistance to extremities of weather

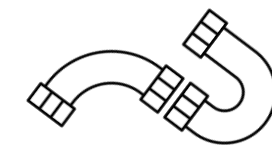

Higher water drainage



Excellent corrosion resistance

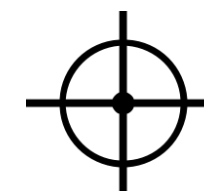

Accurate thickness

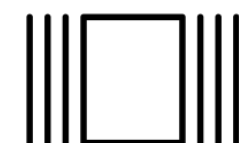

Excellent coverage of space

# Available colors



RAL 6024 - Bright Green



RAL 6025 - Environmental Green

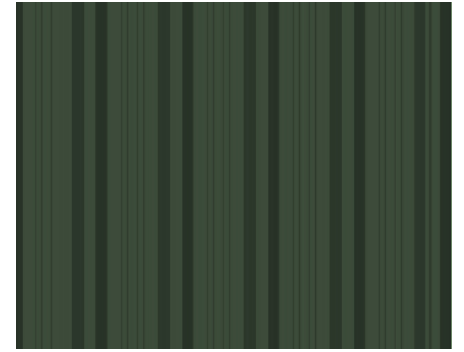

RAL 6005 - Caulfield Green

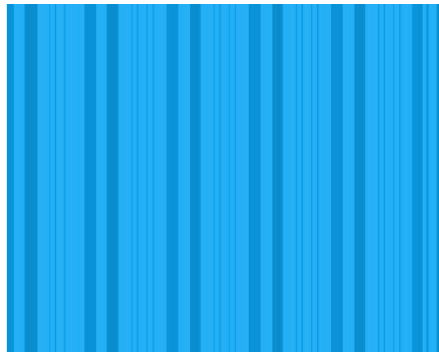

RAL 5012 - Light Blue

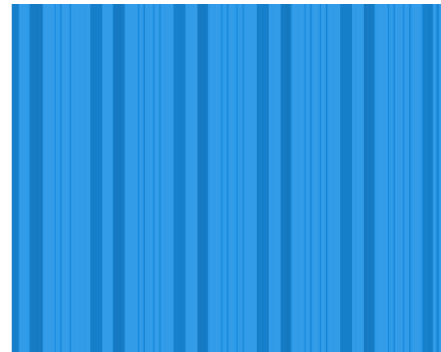

RAL 5015 - Sky Blue



RAL 5017 - Nova Blue

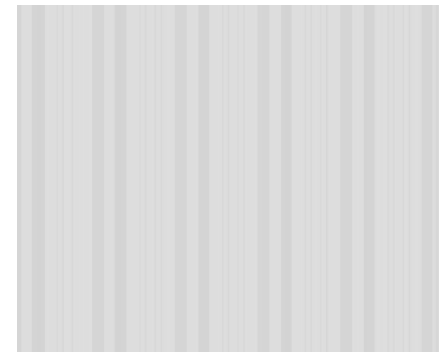

RAL 9010 - Pure White



RAL 9002 - Off White

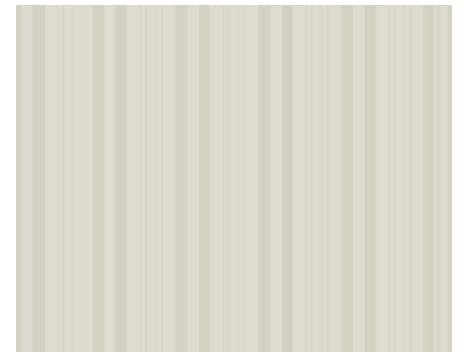

RAL 9001 - Cream White



RAL 3011 - Brick Red



RAL 3004 - Cherry Red



RAL 3013 - Tomato Red

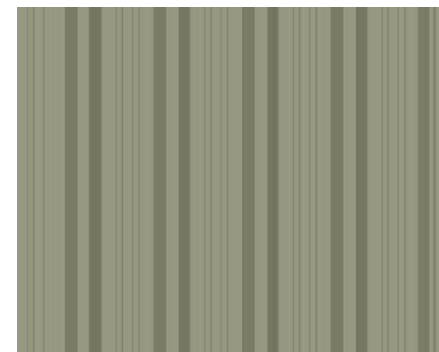

RAL 7030 - Stone Grey



RAL 7033 - Cement Grey

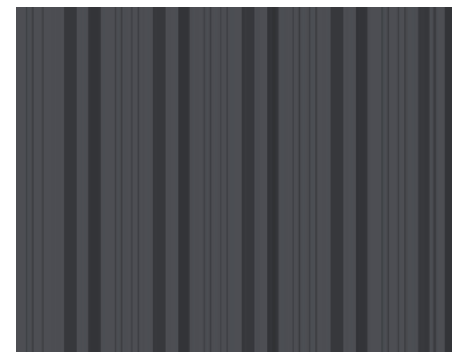

RAL 7024 - Graphite Grey

# Accessories

Ridge



Valley Gutter

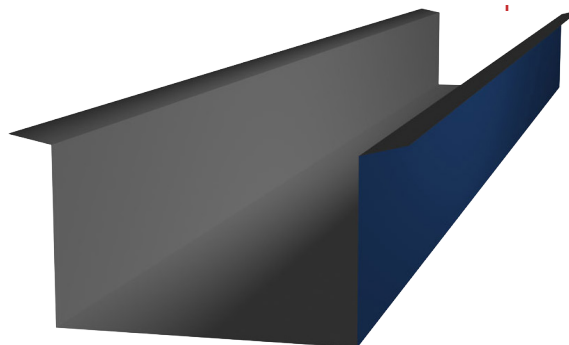

Plain Ridge

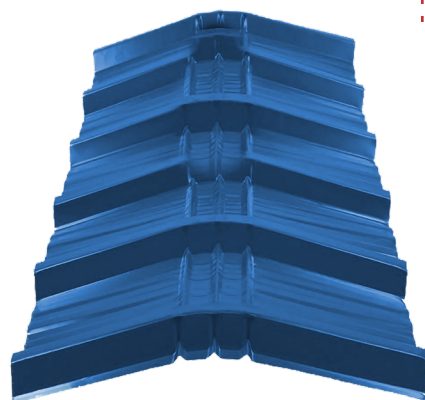

Eaves Gutter



Crimped Ridge

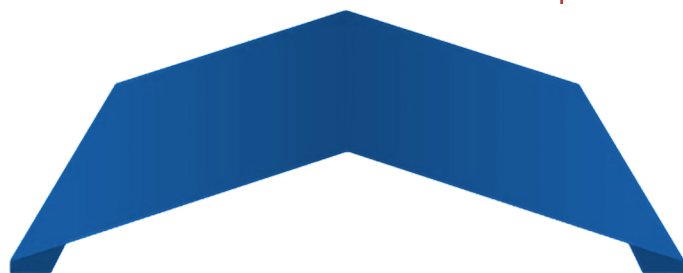

Box Gutter

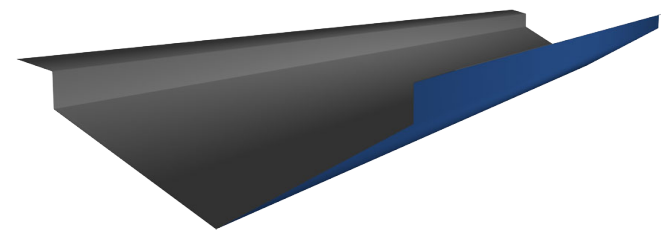

Corner Flashing

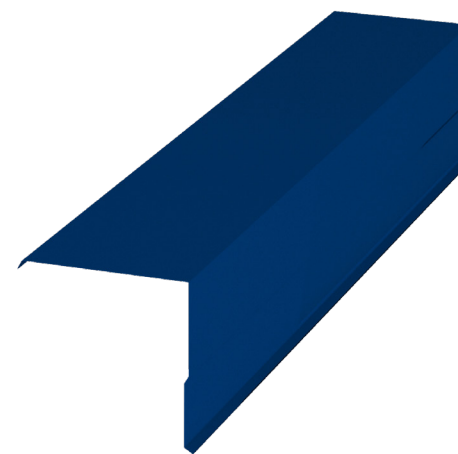

Deep Trime

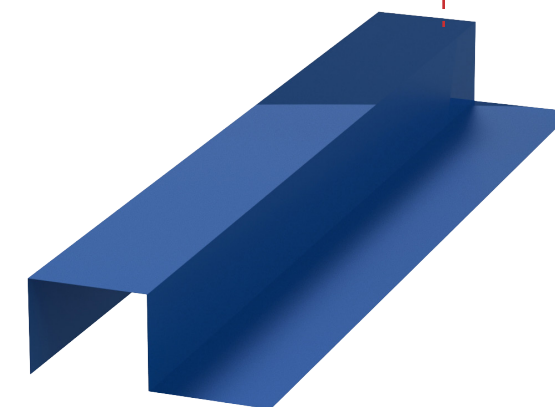

Drip Flashing

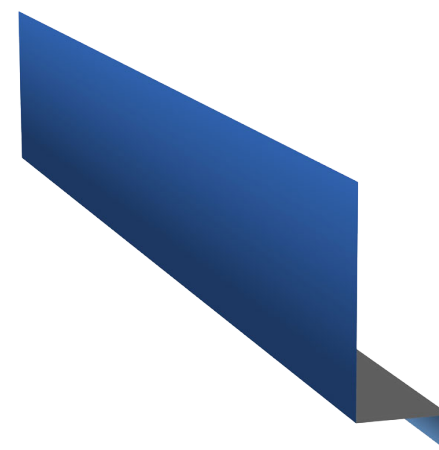

Crimped NLC

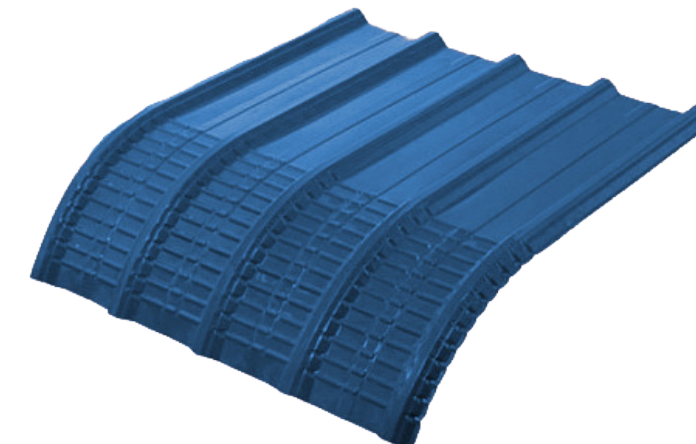

End Wall Flashing

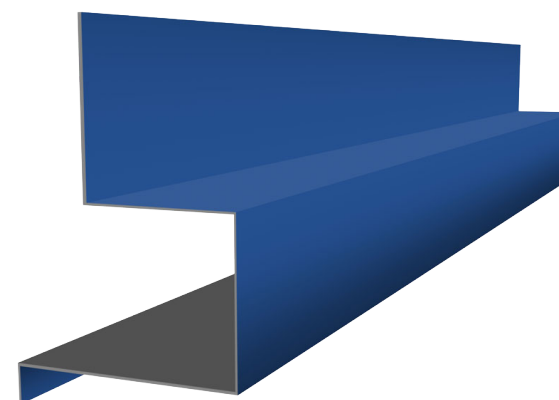

Apron

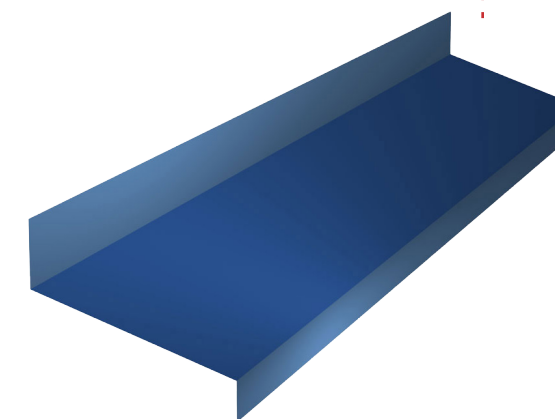

Louvers



Self Tapping Screw



FRP Skylight



Turbo Ventilator



Down Take Pipe



Puf Panel

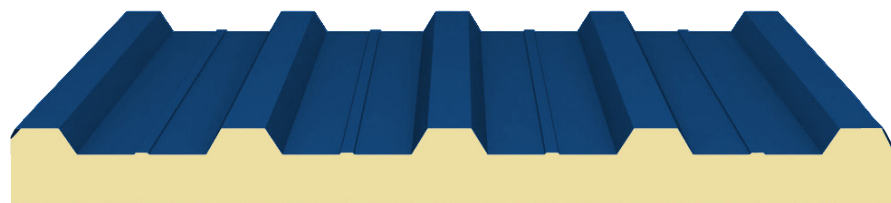

**Z & C**

**PURLIN**

**SHEETS**

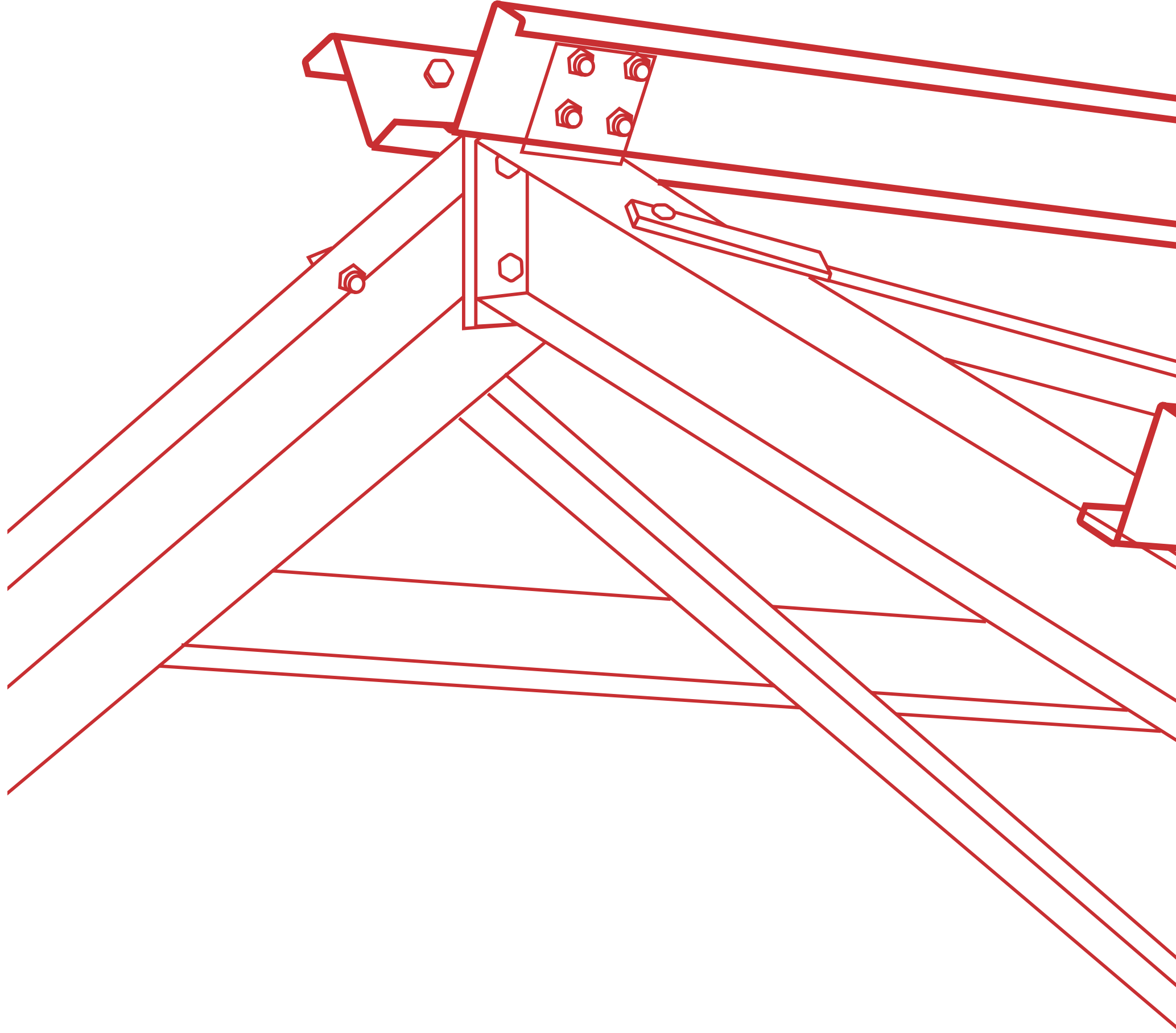

# Z & C PURLINS

JBFS FlexiBal® Z & C Purlins provide the perfect solution to today's industry needs of pre-engineered, pre-cut, precise, superior quality and ready-to-assemble sections. Purlins are beams that are designed to form the roof and wall joists of a building structure, sitting between the roofing sheets and the building, acting as a support for the sheet to ensure it is firmly attached and safely in place. The FlexiBal® Purlins are accurately roll-formed using Precision Automatic Roll Forming machine from high-strength lightweight Galvanized [100% Zinc] / Mild steel to your required dimensions to provide an efficient, lightweight, economical purlin. An excellent choice for all kind of Pre-Engineered Building solutions.

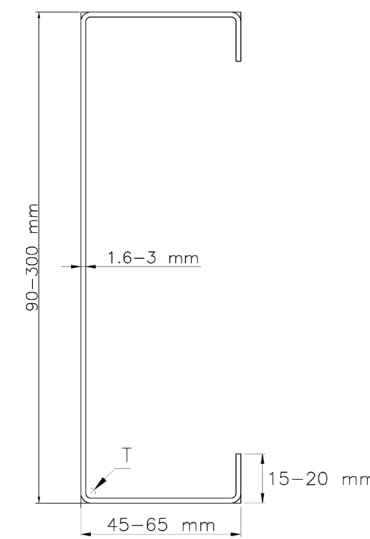

C Purlin

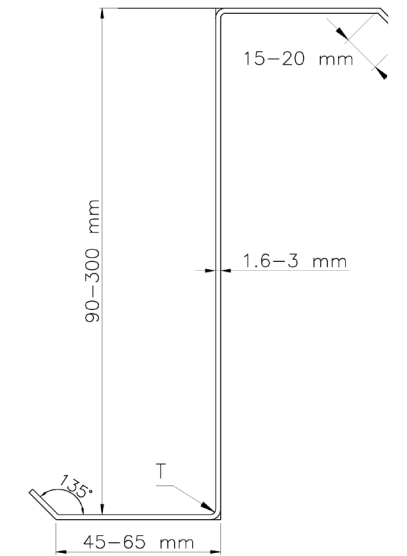

Z Purlin

## Product Details

Material	Mild Steel / Galvanised
Length	as per requirement
Thickness	1.6mm - 3mm
Web	90mm - 300mm
Flange	45 / 50 / 55 / 60 / 65 mm
Lip	15 - 20 mm
Corrosion Coating Mass	120 GSM / 275 GSM
Minimum Yield Strength	240 MPa / 345 MPa / 550 MPa

# Features



High strength to weight ratio

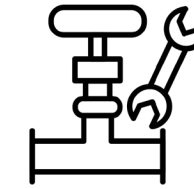

Fast Installation



Environment friendly & Fire proof

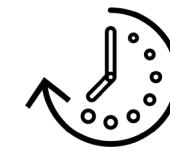

Long Life



Economical



Anti-Corrosion Coating



Very low maintainace



Fire Proof

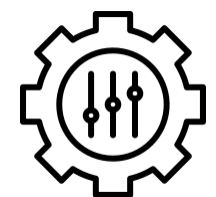

Design Flexibility



# HAT PURLIN SHEETS

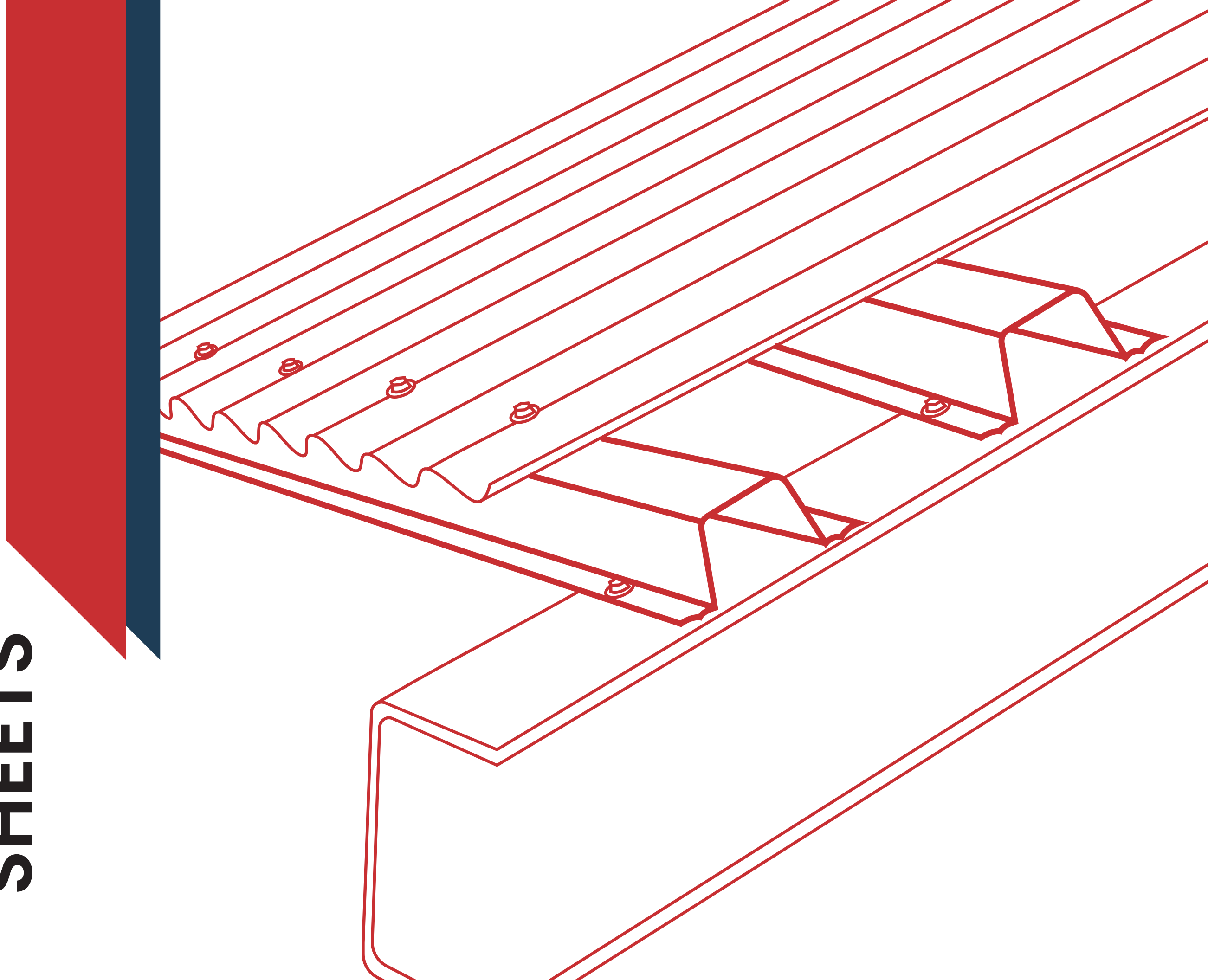

# HAT PURLINS

JBFS FlexiBal® Top Hat Purlins provide the perfect solution to today's industry needs of pre-engineered, pre-cut, precise, superior quality and ready-to-assemble sections. Purlins are beams that are designed to form the roof and wall joists of a building structure, sitting between the roofing sheets and the building, acting as a support for the sheet to ensure it is firmly attached and safely in place. Top Hat Purlin provide a high lateral stiffness making it suitable for applications where the purlin may be subjected to lateral load as well. The FlexiBal® Purlins are accurately roll-formed using Precision Automatic Roll Forming machine from high-strength lightweight Mild Steel base with either Zinc-Aluminium Alloy (Galvalume) [55% Aluminium, 43% Zinc, 1.5% Silicon] or Zinc (Galvanise)[100% Zinc] coating in required dimensions to provide an efficient, lightweight, economical purlin. An excellent choice for all kind of Pre-Engineered Building solutions.

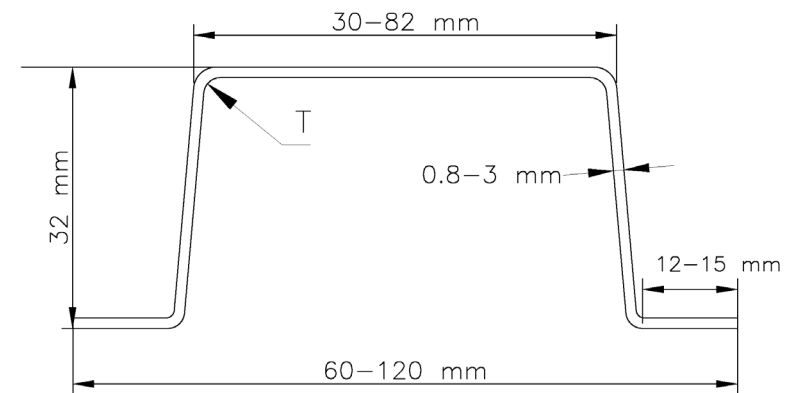
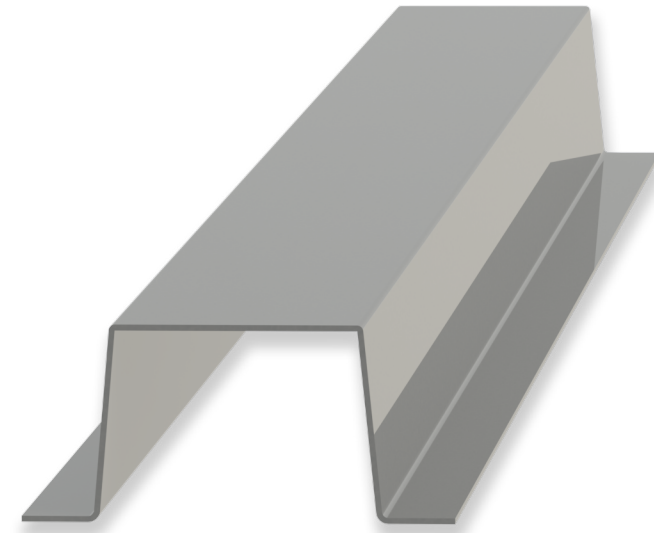

## Product Details

Material	Mild Steel / Galvanised / Galvalume
Length	as per requirement
Thickness	0.8mm - 3mm
Height	32mm
Flange	31mm
Lip	12 - 15 mm
Corrosion Coating Mass	Z-90 / Z-120 / Z-275 / AZ-70 / AZ-150 GSM
Minimum Yield Strength	240 MPa / 345 MPa / 550 MPa



# Features



High strength to weight ratio

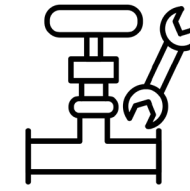

Fast Installation



Environment friendly & Fire proof

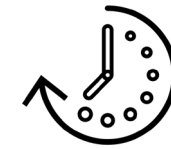

Long Life



Economical



Anti-Corrosion Coating



Very low maintainace



Fire Proof

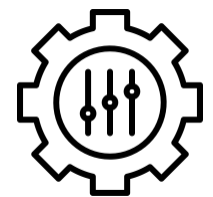

Design Flexibility

**SIGMA**

**PURLIN**

**SHEETS**

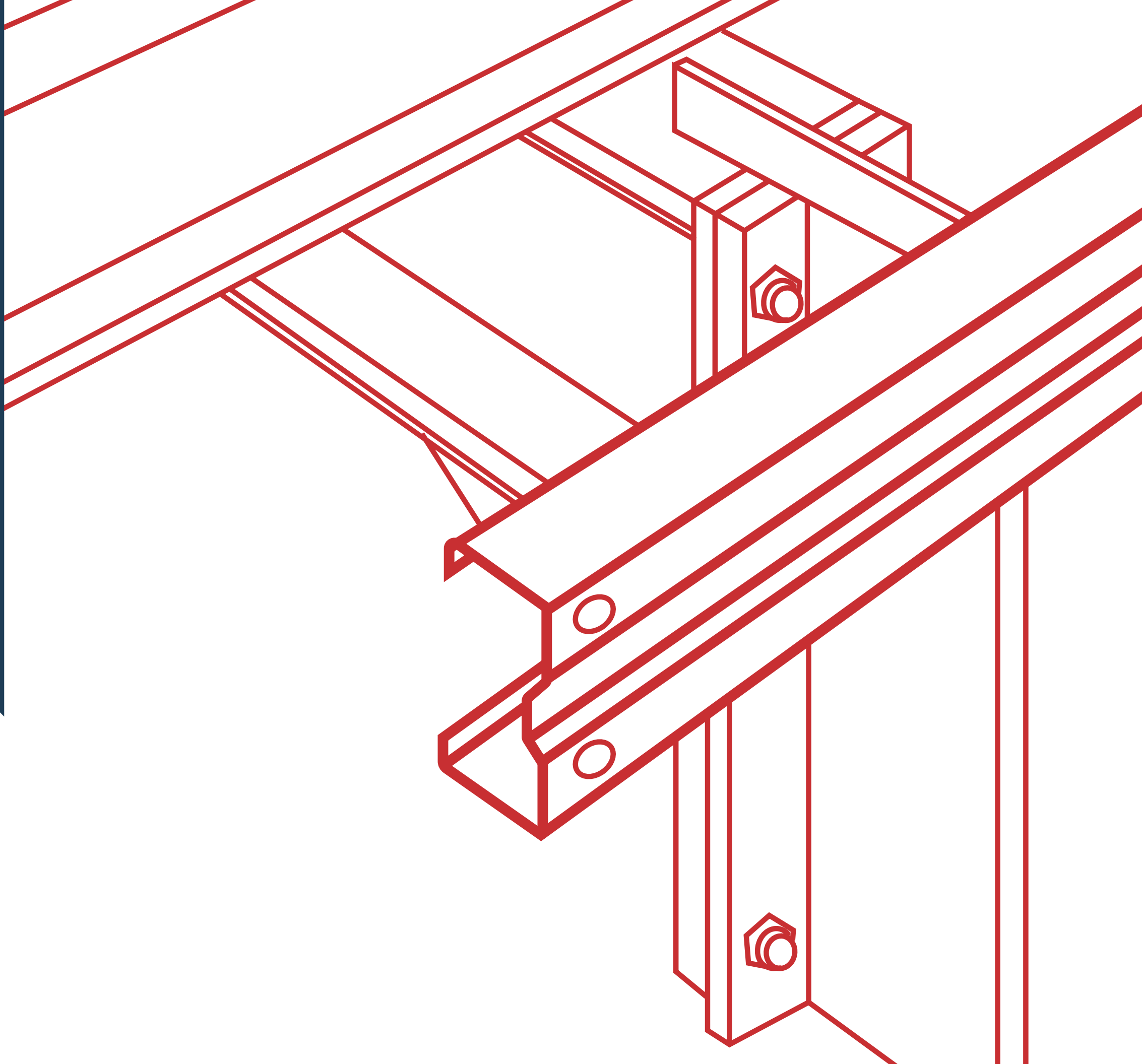

# SIGMA PURLINS

JBFS FlexiBal® Sigma Purlins provide the perfect solution to today's industry needs of pre-engineered, pre-cut, precise, superior quality and ready-to-assemble sections. Purlins are beams that are designed to form the roof and wall joists of a building structure, sitting between the roofing sheets and the building, acting as a support for the sheet to ensure it is firmly attached and safely in place. Sigma Purlin provides better efficiency owing dimensionally smaller plane areas thereby allowing longer span length. The FlexiBal®Purlins are accurately roll-formed using Precision Automatic Roll Forming machine from high-strength lightweight Mild Steel base with Zinc (Galvanise) coating in required dimensions to provide an efficient, lightweight, economical purlin. An excellent choice for all kind of Pre-Engineered Building solutions.

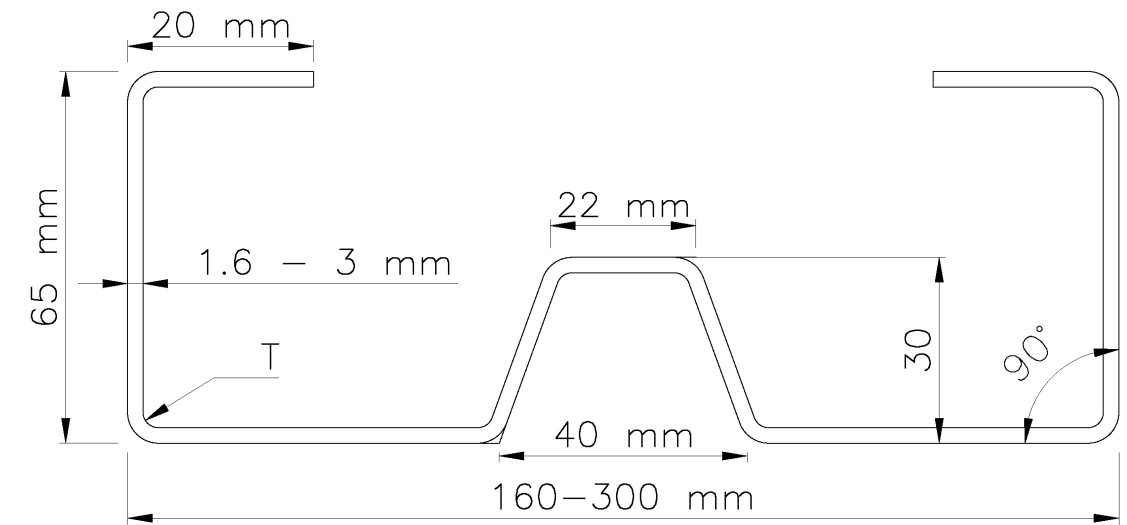
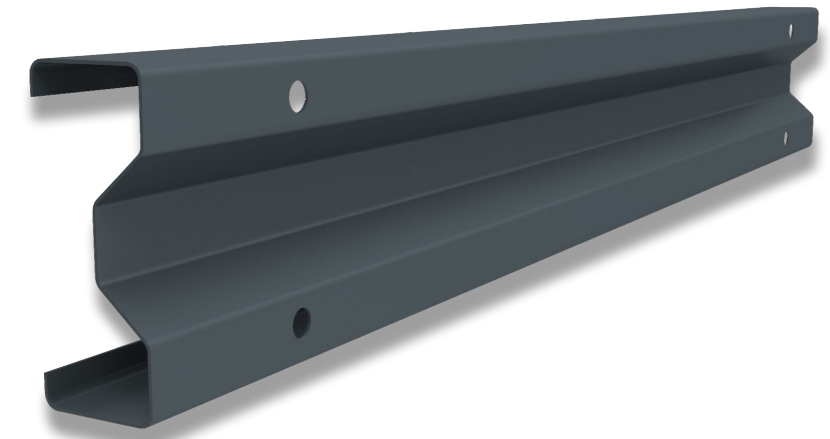

## Product Details

Material	Mild Steel / Galvanised
Length	as per requirement
Thickness	2.4 / 3 / 4 mm
Depth	200mm - 300mm
Flange	65mm
Lip	20mm
Corrosion Coating Mass	120 GSM / 275 GSM
Minimum Yield Strength	240 MPa / 345 MPa



# Features



High strength to weight ratio

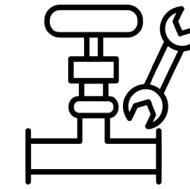

Fast Installation



Environment friendly & Fire proof

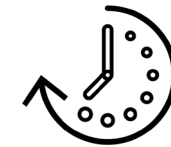

Long Life



Economical



Anti-Corrosion Coating



Very low maintainace



Fire Proof

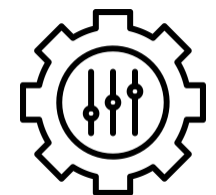

Design Flexibility

# PRESTIGIOUS CLIENTS



We have got you  
**COVERED**

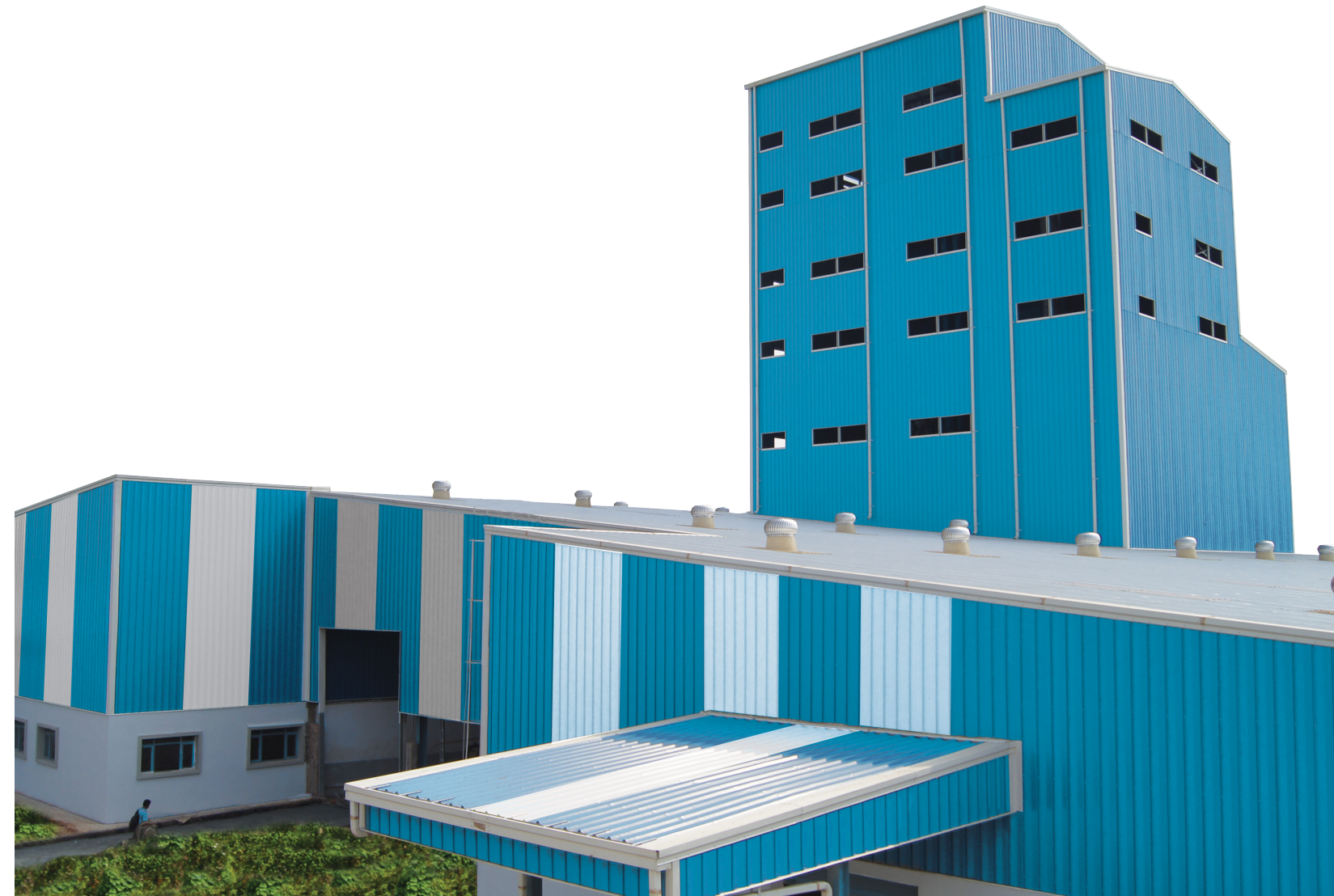



JBFS Engineering Systems Pvt. Ltd. presents to you its range of Smart Structural Solution, a single point comprehensive solution for all your steel structural requirements; ensuring that once you come to us, all you have to do thereafter is relax.

Our innovative and value-based Smart Structural Solution products are admired and acknowledged for its quality, durability, speed, and unmatched value. The products are designed to help you achieve better performance, quality, and cost-effectiveness in your projects through our products.

**Quality you deserve,  
dependability you can count on.**



**City Office:**

35, Chittaranjan Avenue, 4th floor  
Near Indian Airlines Building  
Kolkata - 700012 (W.B.)

**Registered Office:**

Kumar Complex (16 Bigha More),  
Amria, Kolorah, Donjur  
Howrah - 711411 (W.B.)



**Unit 1:**

Kumar Complex (16 Bigha More),  
Amria, Kolorah, Donjur  
Howrah - 711411 (W.B.)

**Unit 2:**

M.J Industrial Park,  
Satghoria, Panchla  
Howrah - 711322 (W.B.)



info@jbfs.co.in



www.jbfs.co.in



9830061186